



SS32F THRU SS320F

Surface Mount Schottky Barrier Rectifier

Reverse Voltage -20 to 200V

Forward Current — 3.0A

FEATURES

- Metal silicon junction, majority carrier conduction
- For surface mounted applications
- Low power loss, high efficiency
- High forward surge current capability
- For use in low voltage, high frequency inverters, free wheeling, and polarity protection applications

MECHANICAL DATA

- Case: SMAF
- Terminals: Solderable per MIL-STD-750, Method 2026
- Approx. Weight: 27mg 0.00086oz

PINNING

PIN	DESCRIPTION
1	Cathode
2	Anode

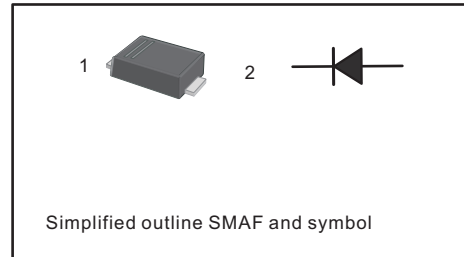

Absolute Maximum Ratings and Electrical characteristics

Ratings at 25 °C ambient temperature unless otherwise specified. Single phase, half wave, 60Hz resistive or inductive load, for capacitive load, derate by 20 %

Parameter	Symbols	SS32F	SS34F	SS36F	SS38F	SS310F	SS312F	SS315F	SS320F	Units
Maximum Repetitive Peak Reverse Voltage	V_{RRM}	20	40	60	80	100	120	150	200	V
Maximum RMS voltage	V_{RMS}	14	28	42	56	70	84	105	140	V
Maximum DC Blocking Voltage	V_{DC}	20	40	60	80	100	120	150	200	V
Maximum Average Forward Rectified Current	$I_{F(AV)}$	3.0								A
Peak Forward Surge Current, 8.3ms Single Half Sine-wave Superimposed on Rated Load (JEDEC method)	I_{FSM}	80				70				A
Max Instantaneous Forward Voltage at 3 A	V_F	0.55		0.70		0.85		0.95		V
Maximum DC Reverse Current $T_a = 25^\circ\text{C}$ at Rated DC Reverse Voltage $T_a = 100^\circ\text{C}$	I_R	0.5 10		0.3 5						mA
Typical Junction Capacitance ¹⁾	C_j	250			160					pF
Typical Thermal Resistance ²⁾	$R_{\theta JA}$	40								°C/W
Operating Junction Temperature Range	T_j	-55 ~ +125								°C
Storage Temperature Range	T_{stg}	-55 ~ +150								°C

1) Measured at 1MHz and applied reverse voltage of 4 V D.C.

2) P.C.B. mounted with 0.2 X 0.2" (5 X 5 mm) copper pad areas.



Fig.1 Forward Current Derating Curve

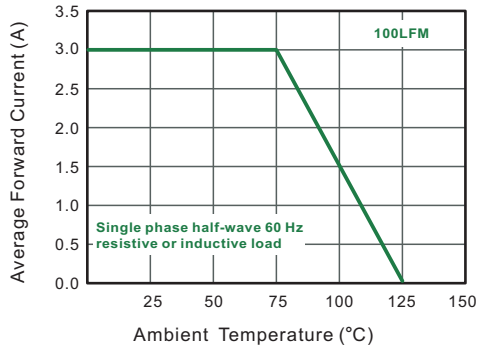

Fig.2 Typical Reverse Characteristics

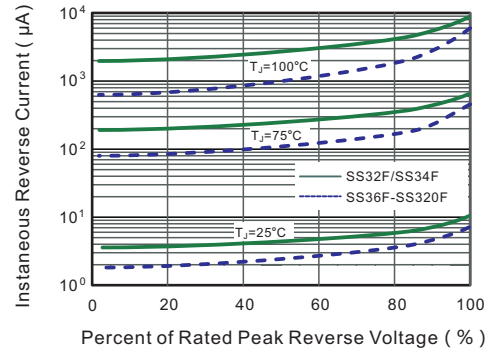

Fig.3 Typical Forward Characteristic

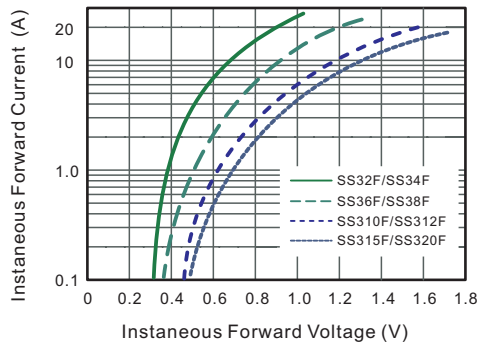

Fig.4 Typical Junction Capacitance

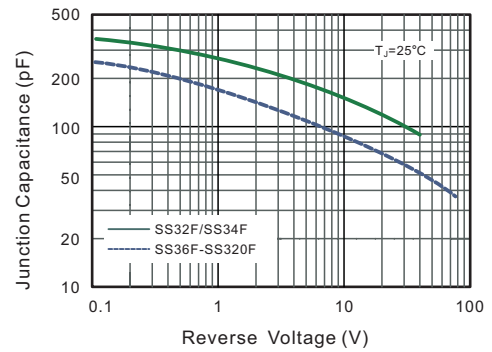

Fig.5 Maximum Non-Repetitive Peak Forward Surge Current

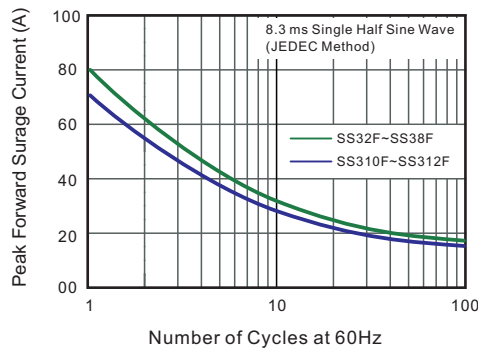
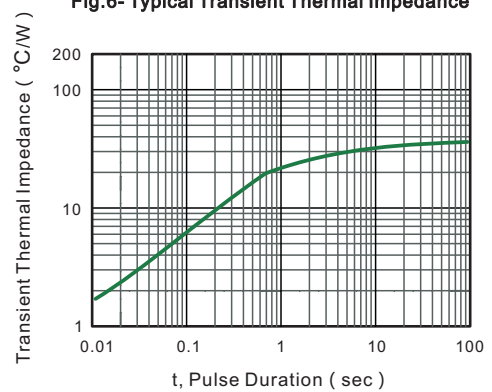

Fig.6- Typical Transient Thermal Impedance





SHENZHEN FAITH TECHNOLOGY CO.,LTD

SCHOTTKY BARRIER RECTIFIER

SS32F THRU SS320F

PACKAGE OUTLINE

Plastic surface mounted package; 2 leads

SMAF

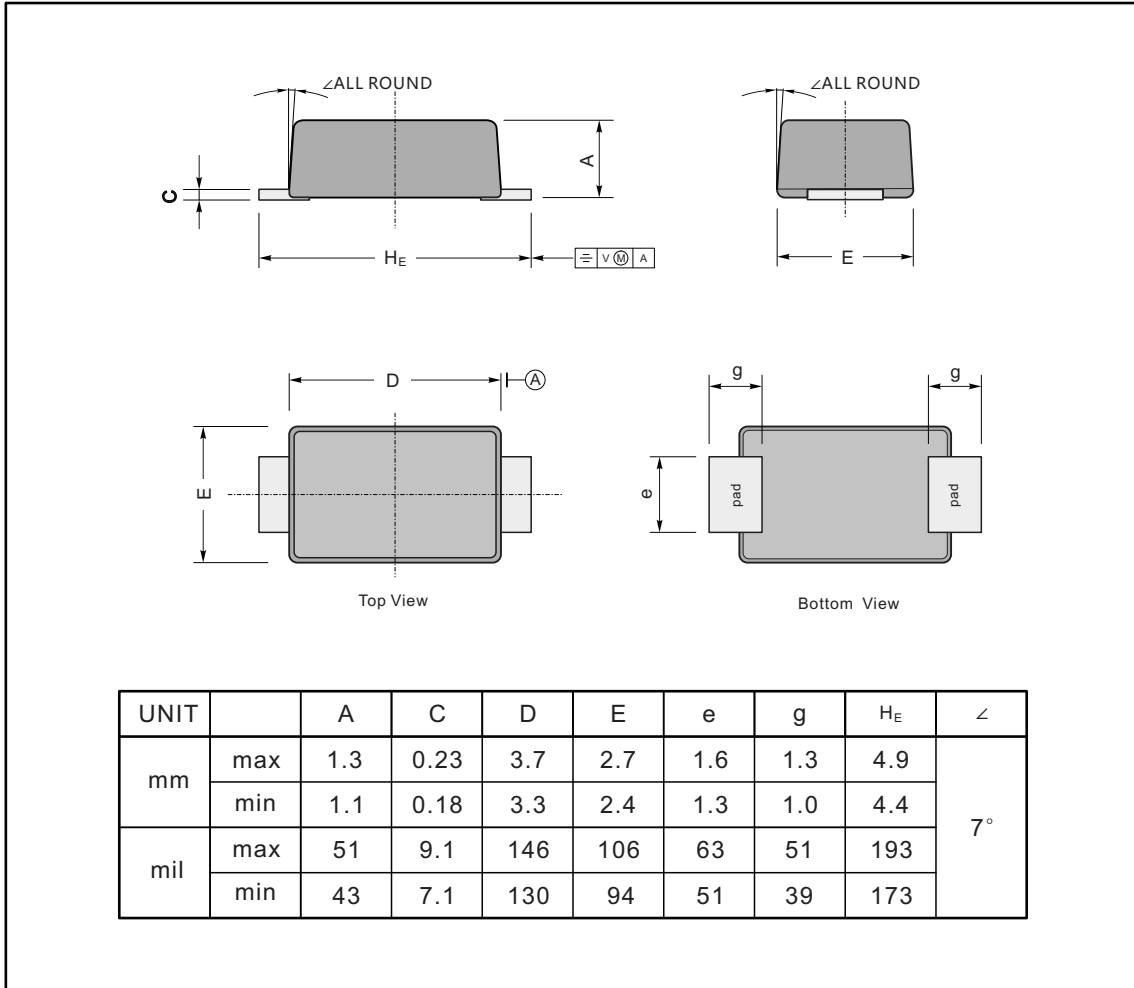

The recommended mounting pad size

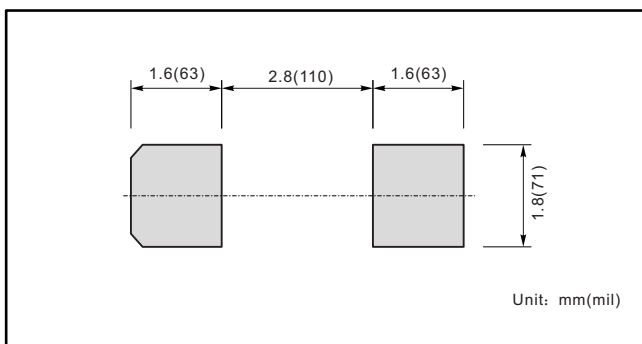

Marking

Type number	Marking code
SS32F	SS32
SS34F	SS34
SS36F	SS36
SS38F	SS38
SS310F	SS310
SS312F	SS312
SS315F	SS315
SS320F	SS320